

Technische Daten: Art.-Nr.: 350190
Wandaußenmaß: 395 x 366 cm
Bohlenstärke: 70 mm



Kontrolliert durch:

Empty rectangular box for signature or name.

Achtung: Alle angegebenen Maße sind ca.-Maße!

3D-Darstellung 350190

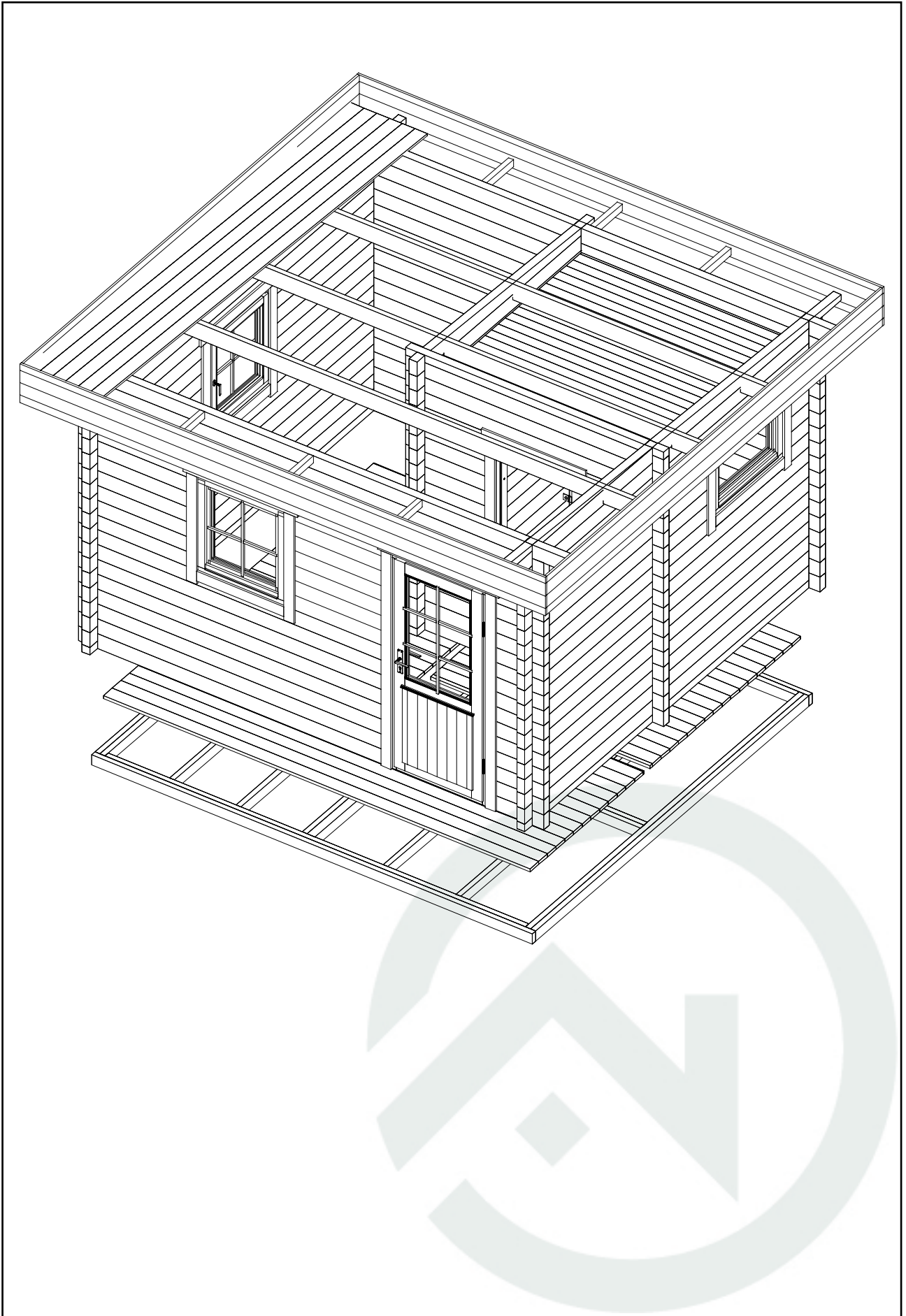

Grundriss 350190

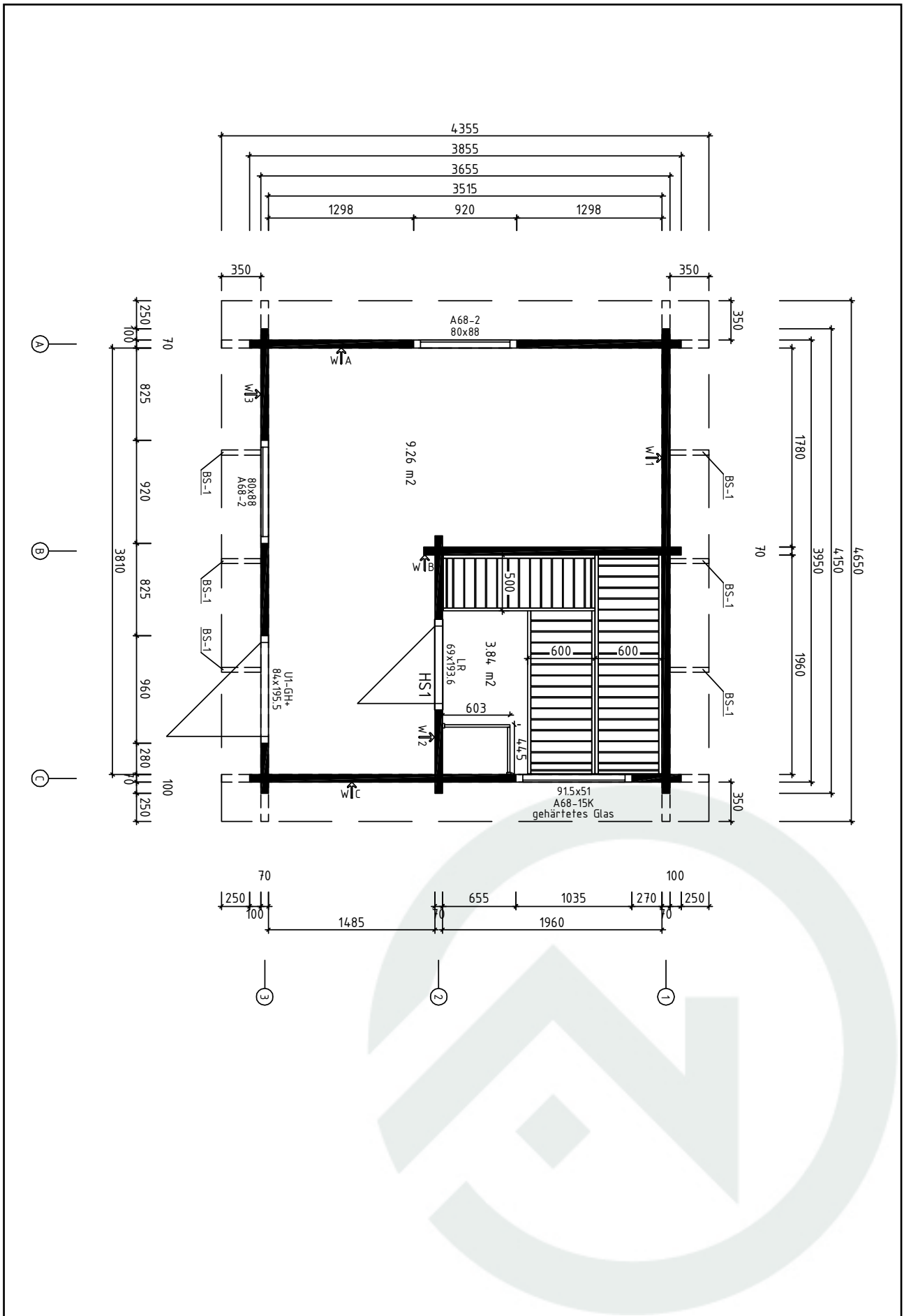





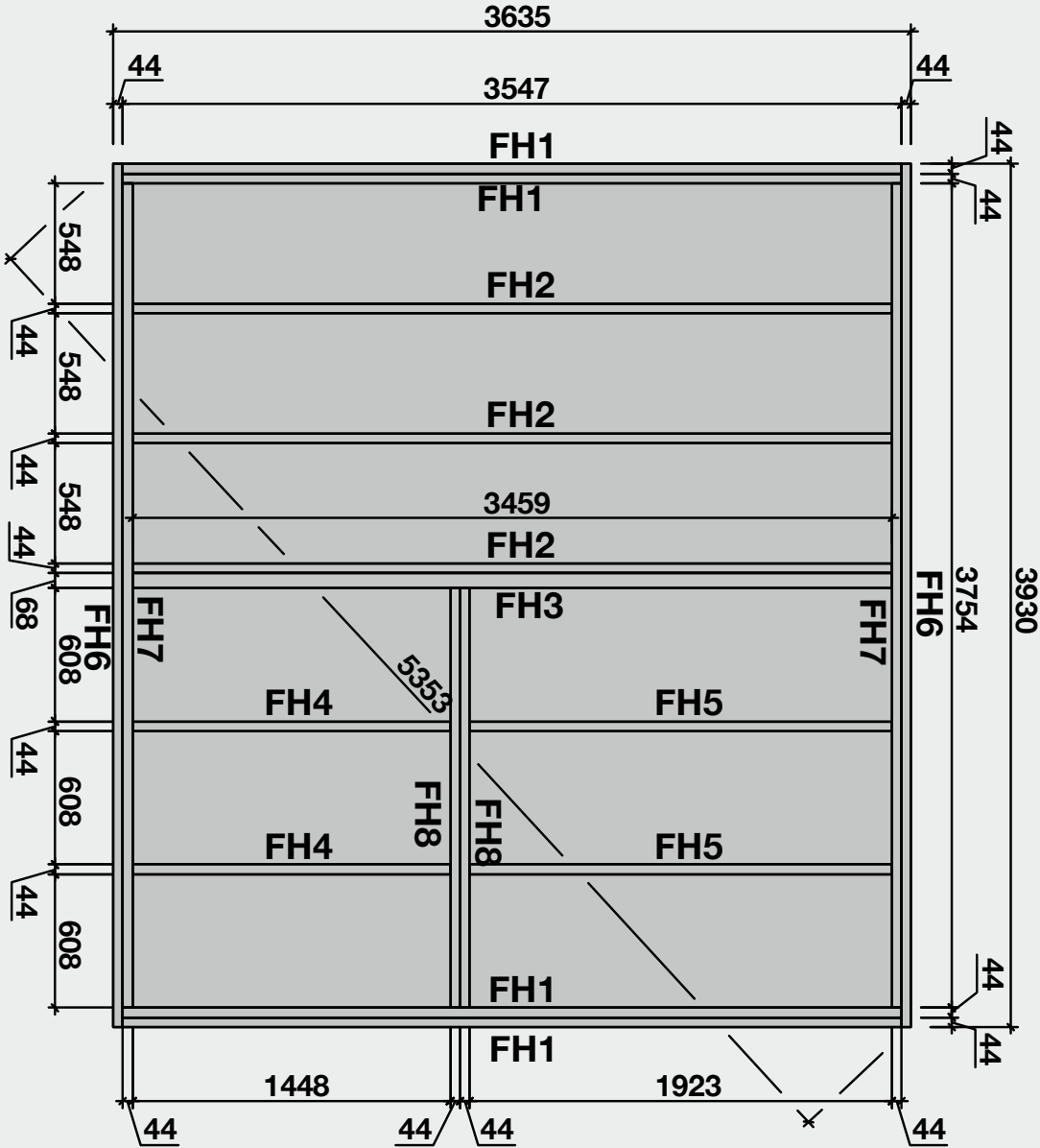



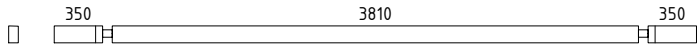
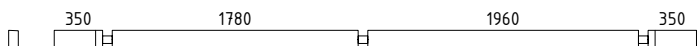

Lagerholzplan und Fundamentplan 350190

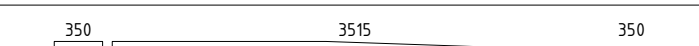
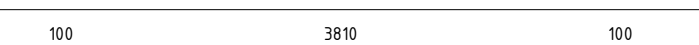
Wir empfehlen als Fundament für Ihr Gartenhaus eine vollflächig festgegründete, gepflasterte oder betonierte Fläche.
Wahlweise ist auch ein Punkt- oder Streifenfundament möglich.

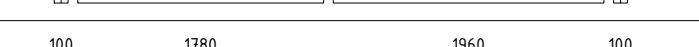
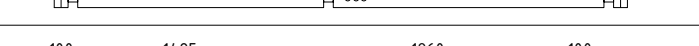
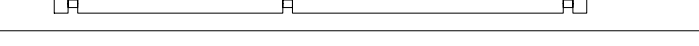
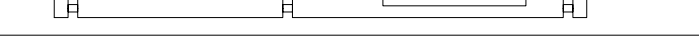
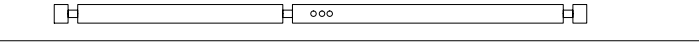
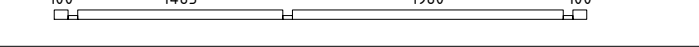
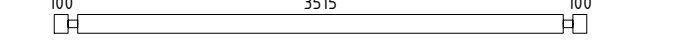
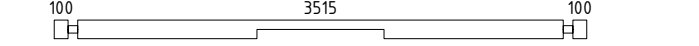
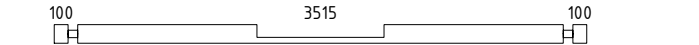
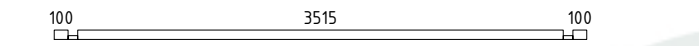
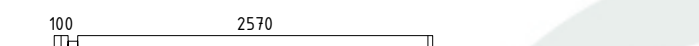

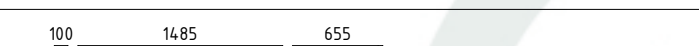
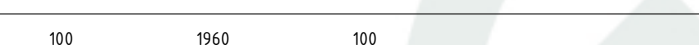
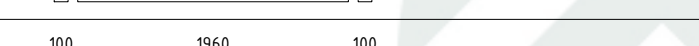
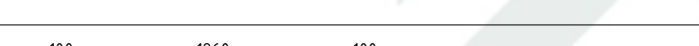

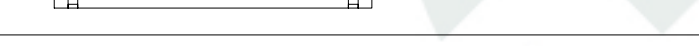







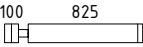
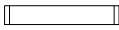
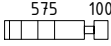
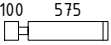









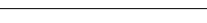
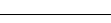

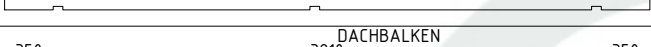
Teileliste 1

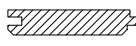
350190

Pos		Stck	Profil (mm)	Länge (mm)
001		1	70x123	4650
002		1	70x135	4650
003		1	70x135	4355
004		1	70x135	4355
005		3	70x135	4150
006		15	70x135	4150
007		2	70x135	4150
008		11	70x135	3855
009		1	70x135	3855
010		1	70x135	3855
011		1	70x68	3855
012		9	70x135	3855
013		1	70x135	3855
014		1	70x135	3855
015		1	70x68	3855
016		7	70x135	2740
017		1	70x135	2740
018		4	70x135	2380
019		1	70x135	2300
020		1	70x70	2300
021		20	70x135	2300
022		1	70x68	2300
023		1	70x68	1968
024		1	70x68	1905
025		12	70x135	1468











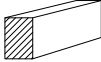



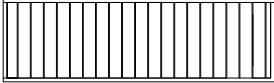
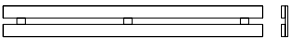
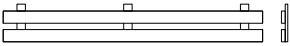

Teileliste 2

350190

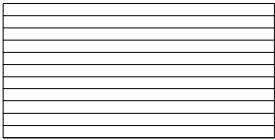
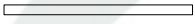
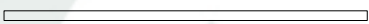
Pos		Stck	Profil (mm)	Länge (mm)
026		7	70x135	995
027		7	70x135	825
028		14	70x135	745
029		16	70x135	745
030		15	70x135	450
031		4	70x135	440
FH3	FUNDAMENTHÖLZER (imprägniert) 	1	68x94	3459
FH6	FUNDAMENTHÖLZER (imprägniert) 	2	44x94	3930
FH7	FUNDAMENTHÖLZER (imprägniert) 	2	44x94	3754
FH1	FUNDAMENTHÖLZER (imprägniert) 	4	44x94	3547
FH2	FUNDAMENTHÖLZER (imprägniert) 	3	44x94	3459
FH5	FUNDAMENTHÖLZER (imprägniert) 	2	44x94	1923
FH8	FUNDAMENTHÖLZER (imprägniert) 	2	44x94	1911
FH4	FUNDAMENTHÖLZER (imprägniert) 	2	44x94	1448
HS1	HOLZSCHWELLE  (unter der Saunatur) ✓	1	75x28	810
DB1	DACHBALKEN 	2	44x145	4650
DB2	DACHBALKEN 	1	44x145	4650
	DACHBRETTER  oder 	42+1 53+1	113x18 88x18	4260
	FUSSBODENBRETTER 	14+1	113x28	3805
	FUSSBODENBRETTER 	18	113x28	1955
	FUSSBODENBRETTER 	18	113x28	1775
	ABDECKLEISTEN  ✓		15x28	18,0 lfdm
	FUSSBODENLEISTE  ✓		14x55	23,0 lfdm
BL-1	DACHBLENDEN 350mm 	2	18x350	4355
BL-2	DACHBLENDEN 350mm 	2	18x350	4686



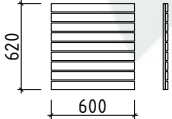





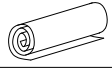

Teileliste 3

350190

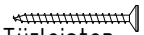
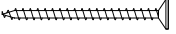
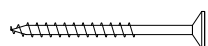
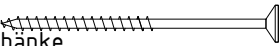
Pos		Stck	Profil (mm)	Länge (mm)
BS-1	DACHBLENDEN- Blendenstützen 44x65 	6	44x65	350
UPB-1	DACHBLENDEN- U-Profil für Blenden 	✓	65x44	19,0 lfdm
DPL-1	DACHPAPPENLEISTE 15x28 	✓	15x28	14,0 lfdm
T4-1	TRAUFENLEISTE 40x18 	✓	40x18	10,0 lfdm
TL3-1	T-LEISTE 70 	2	70x45	490
TL3-2	T-LEISTE 70 	2	70x45	760
TL3-3	T-LEISTE 70 	2	70x45	895
TL3-4	T-LEISTE 70 	4	70x45	1975
	SAUNABANK /Espe/ 60 cm/50 cm 	2	ca 600x90	1955
		1	ca 500x90	1355
	RÜCKLEHNE /Espe/ 	2	ca 250x39	1860
	BÄNKE ZWISCHENSTÜCK /Espe/ 	1	ca 350x39	1955
	KOPFSTÜTZE /Espe/ 	2	ca 444x300	
	DECKENISOLATION 	2 Elemente	ca 1950x975	
	TRÄGELEISTE FÜR SAUNABÄNKE 	3	ca 30x40	600
	TRÄGELEISTE FÜR SAUNABÄNKE 	2	ca 30x40	1200
	TRÄGELEISTE FÜR DECKENISOLATION 	✓	4	35x35 2000
	HEIZUNG UMBAU 		2 Elemente	
	LUFTSCHIEBER 	3		
	BODENROST /Fichte/ 	1	600x620	
	STÜTZPFOSTEN FÜR SAUNABÄNKE 	✓	1	44x68 500
	STÜTZPFOSTEN FÜR SAUNABÄNKE 	✓	2	44x68 1000

Teileliste 4

350190

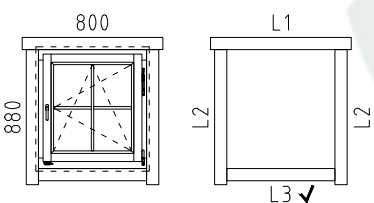
Pos		Stck	Profil (mm)	Länge (mm)
SH	Schlaghölzer 	3		
	DACHPAPPE  ✓		5,4m-6st.	34,0 lfdm
NG3	DACHPAPPNÄGEL 2.0x18 	420		
NG1	NÄGEL 2.5x50 Dachbretter 	423 530	113x18 oder 88x18	
NG2	NÄGEL 2.5x60 Fussbodenbretter 	496		
SR01	SCHRAUBEN 3.0x30 Abdeckleiste, Fussbodenleiste Dachpappenleiste 28x15 Traufenleiste 40x18, Bänke Zwischenstück, Luftschieber 	148		
SR03	SCHRAUBEN 3.5x45 U-Profil für Blenden Heizung Umbau, Fenster- und Türleisten 	158		
SR05	SCHRAUBEN 4.0x60 Trägleiste für Saunabänke, Rücklehne Trägleiste für Deckenisolation 	53		
SR10	SCHRAUBEN 5.0x70 Blendenbefestigung 	52		
SR11	SCHRAUBEN 5.0x100 Fundamenthölzer Stützpfeiler für Saunabänke 	82		
SMS	Schlossschrauben M8x70 Mutter U-Scheibe  für Verbinden der Saunabänke 600+500mm in der Ecke	2		
KL1	Gewindestange M8 	4		2000
KL2	Gewindestange M8  ✓	2		585
KL3	Gewindestange M8  ✓	2		460
	Mutter M8 U-Scheibe Ø25 	8		
	Befestigungsmutter M8 	4		
	Dichtungsband für Deckenisolationselemente ✓		ca 8,0 lfdm	
	FENSTER 800x880 	2	A68-2	

Teileliste 5

350190

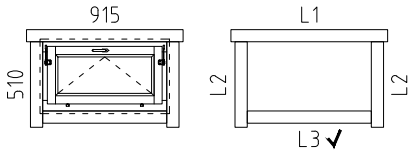
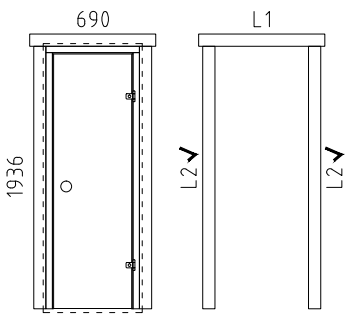
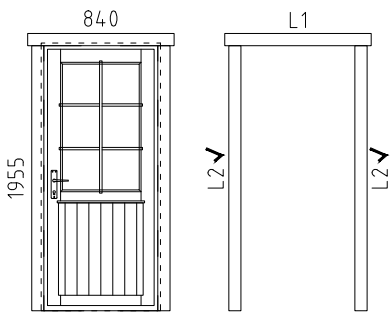
Pos		Stck.	Profil (mm)	Länge (mm)
	<p>FENSTER 915x510</p>  <p>A68-15K</p> <p>L1 18x90 L=1155mm 2x L2 18x90 L=630mm 4x L3 18x90 L=915mm 2x ✓</p>	1	A68-15K	
	<p>TÜR 690x1936</p>  <p>LR</p> <p>L1 18x90 L=930mm 2x L2 18x90 L=1935mm 4x ✓</p> <p>DIN rechts</p>	1	LR	
	<p>TÜR 840x1955</p>  <p>U1-GH+</p> <p>L1 18x90 L=1080mm 2x L2 18x90 L=1955mm 4x ✓</p> <p>DIN rechts</p>	1	U1-GH+	
<p>Achtung Hinweis: wir empfehlen die Stromverkabelung für den Elektro-Saunaofen <u>vor</u> Verlegung von den Fußbodenbrettern durchzuführen.</p>				
	✓ - bitte selber anpassen (falls nötig)!			

Wandplan 1 und 2 350190

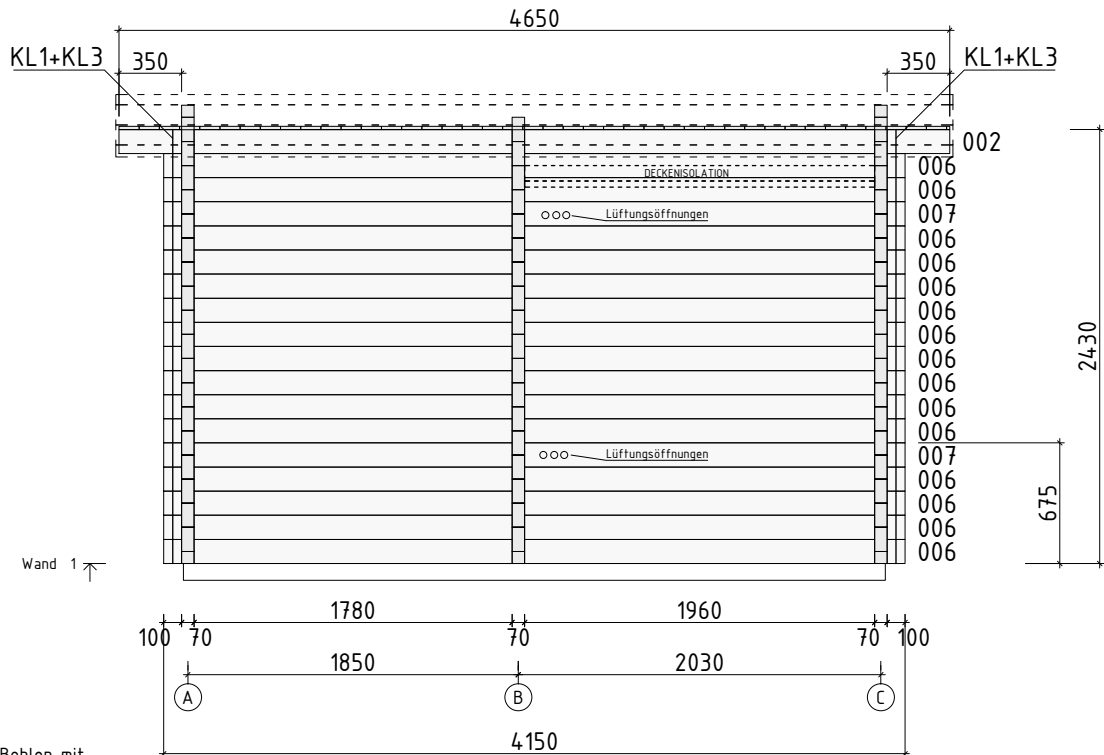

Die Bohlen mit Lüftungsöffnungen können je nach Bedarf höher oder niedriger eingesetzt werden. Bitte achten Sie darauf dass die Lüftungsöffnungen von innen nicht mit der Saunabank bedeckt werden!

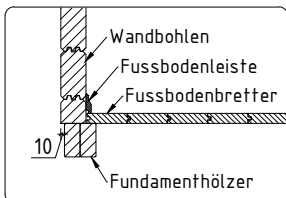
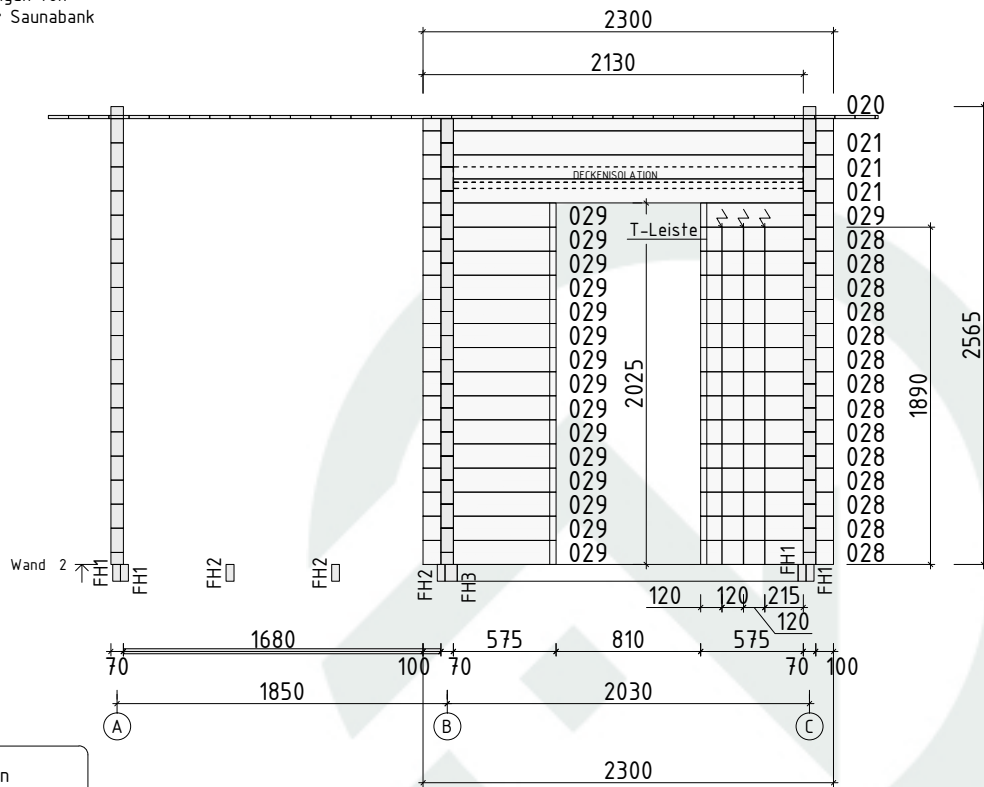

↘ -Bohrung für elektrische Kabel

Wandplan 3 350190

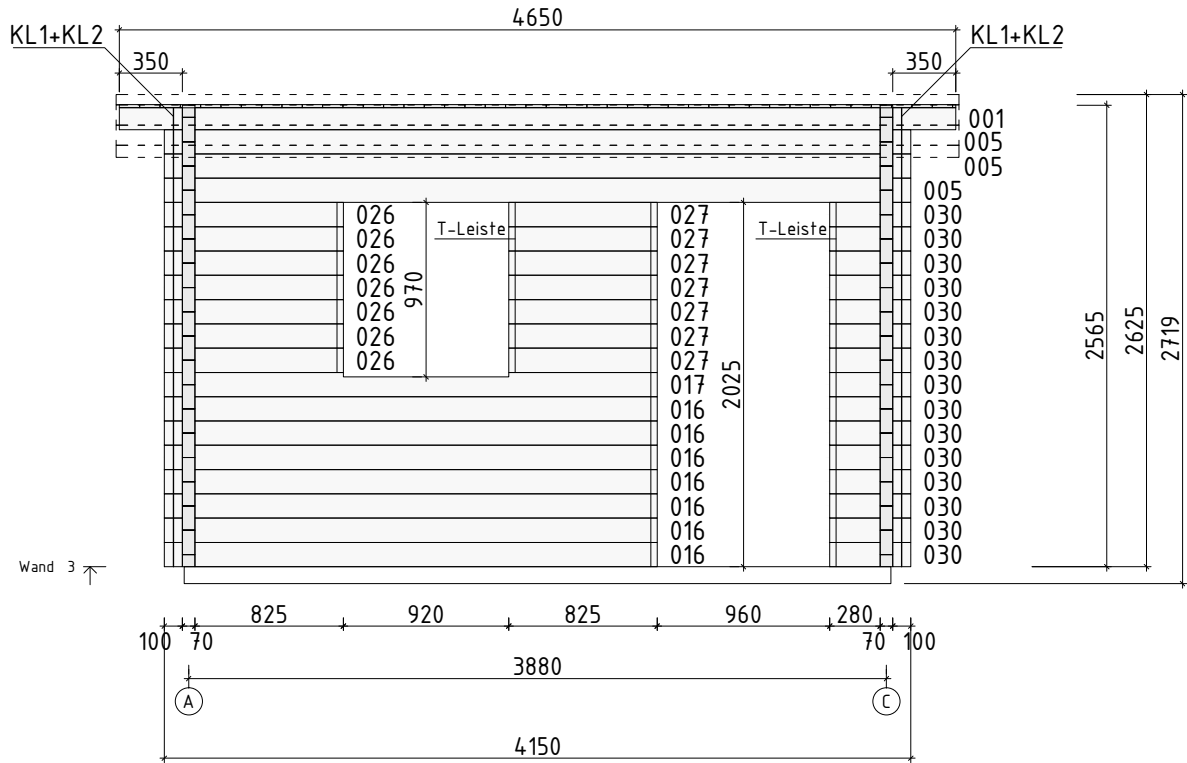

Wandplan A 350190

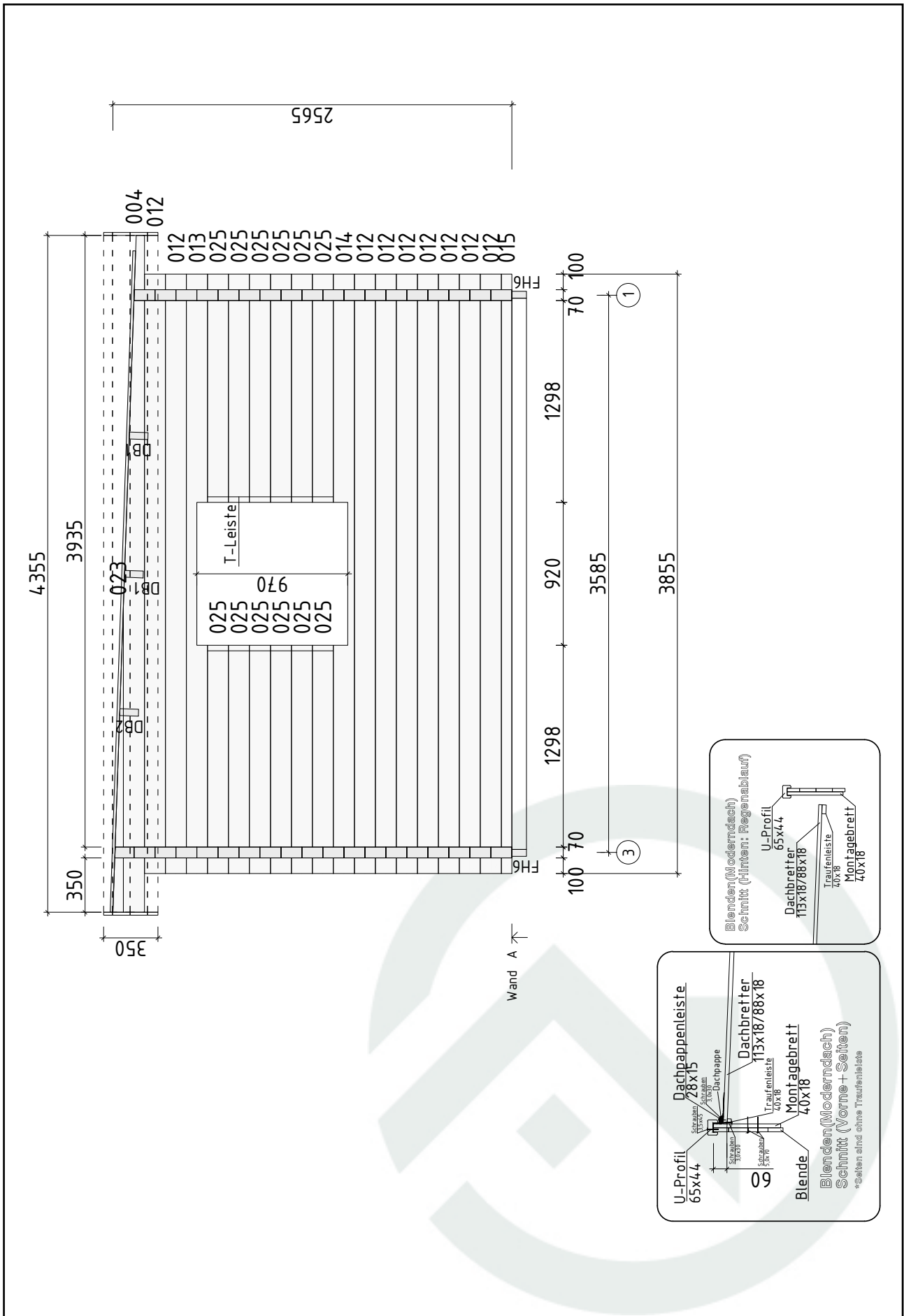

Wandplan B und C 350190

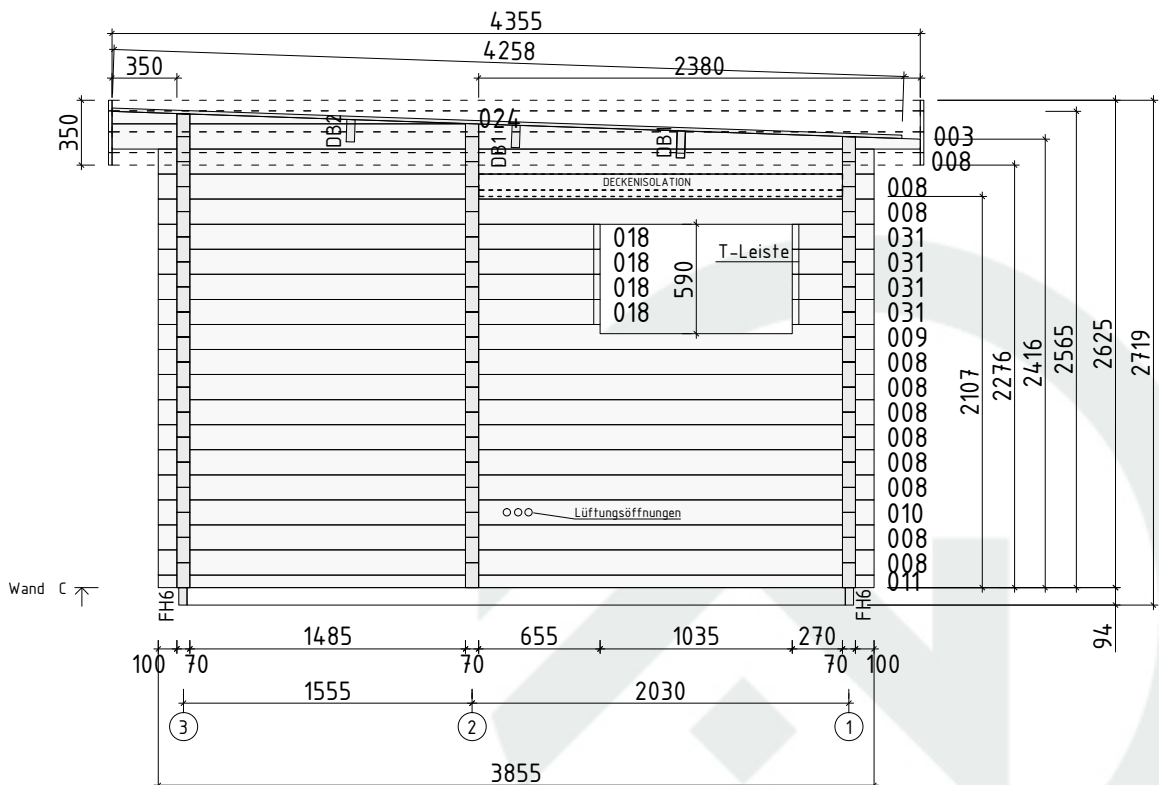
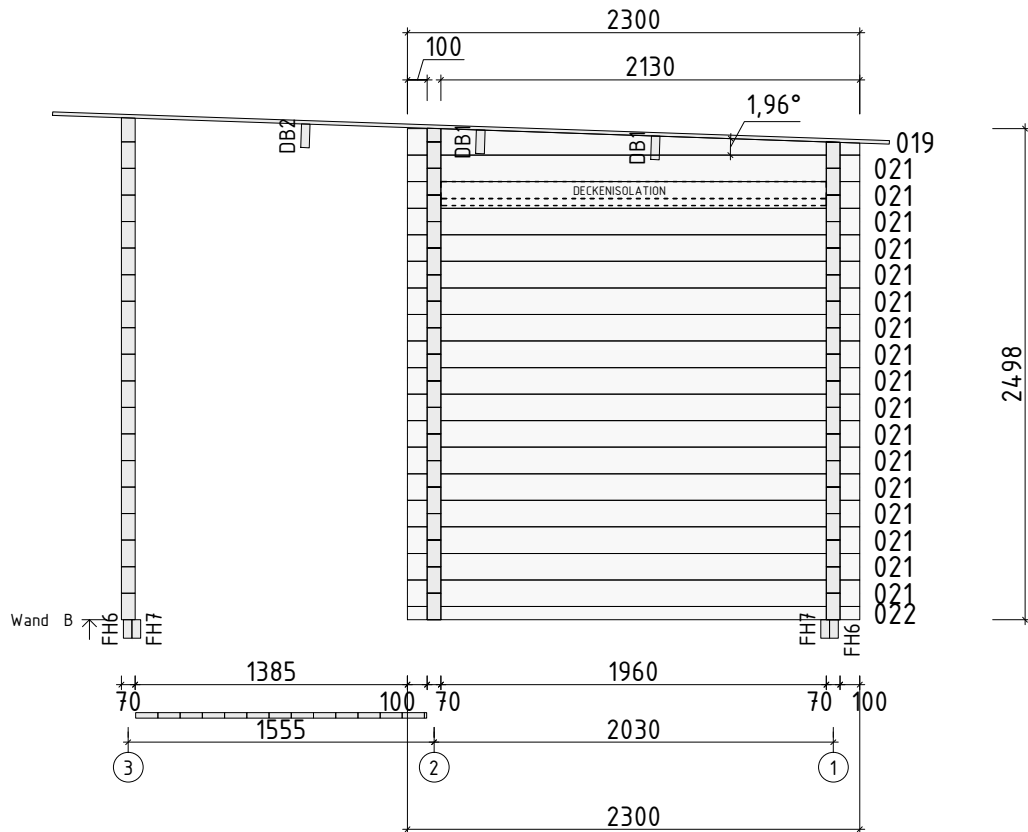

Die Bohlen mit Lüftungsöffnungen können je nach Bedarf höher oder niedriger eingesetzt werden. Bitte achten Sie darauf dass die Lüftungsöffnungen von innen nicht mit der Saunabank bedeckt werden!

Detail / optional

350190

Montageanleitung für T-Leisten / Installing the door and window supports / Tenderliistu paigaldusjuhend.

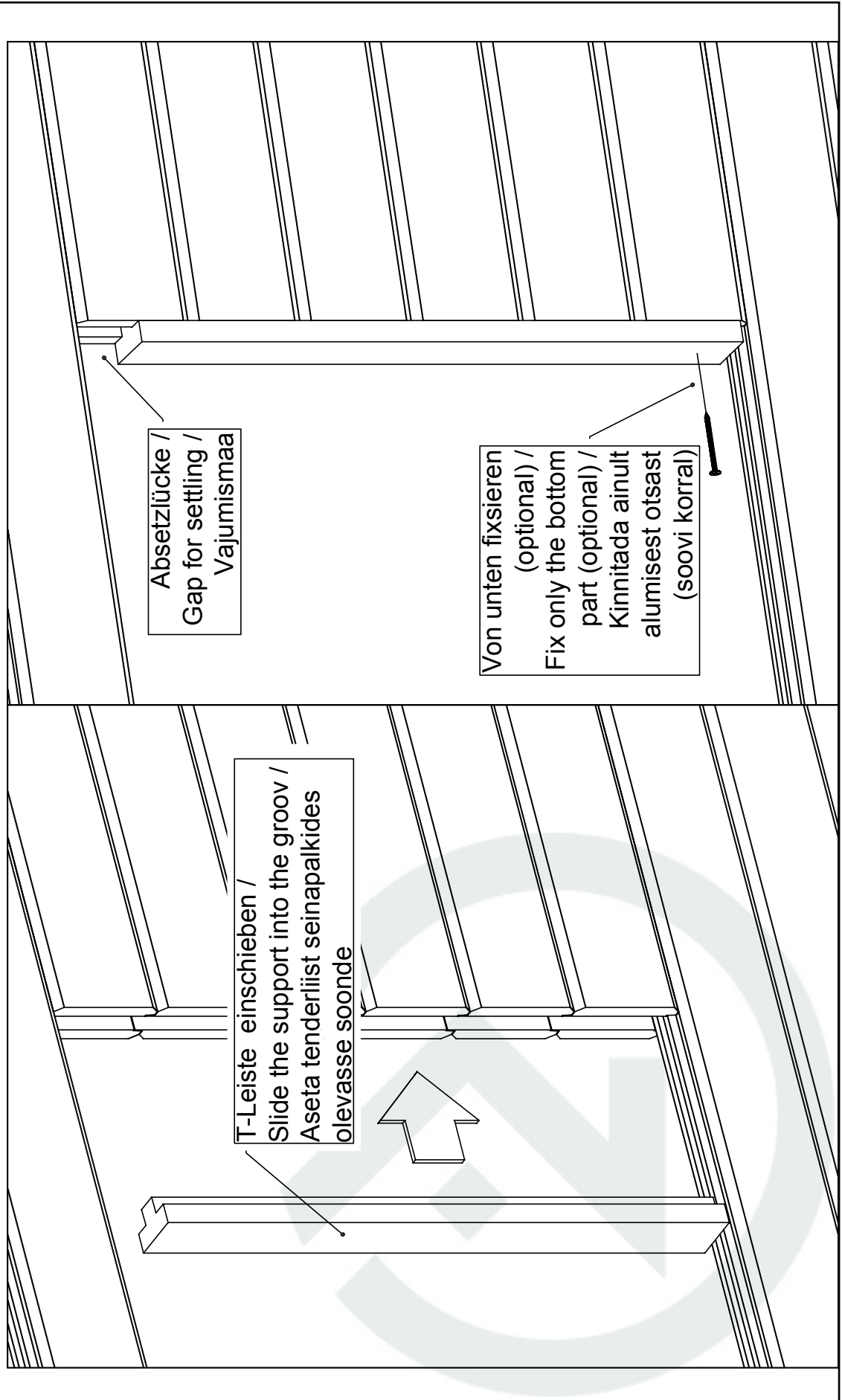

Detail / optional

350190

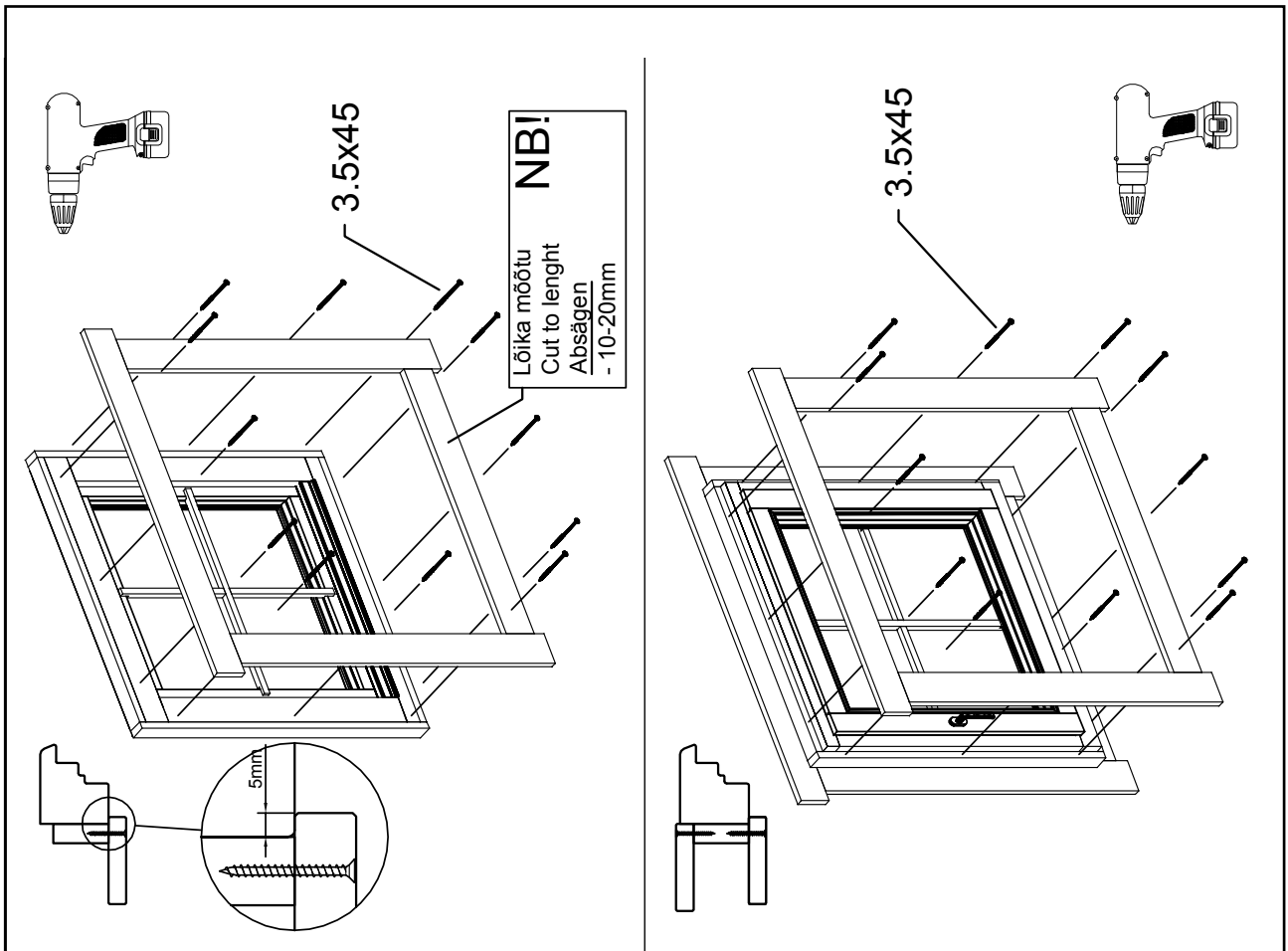

Akna tüüp / Fenster typ / Window type - A68
(GH+ / SH)

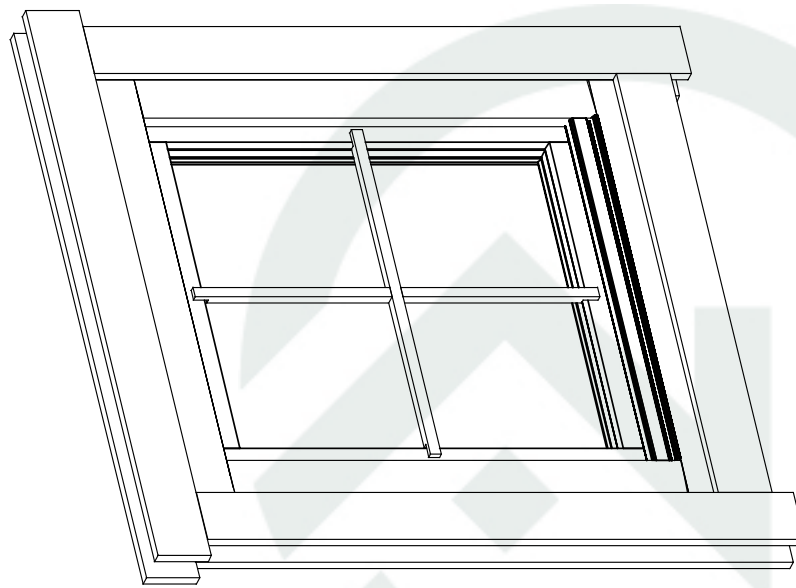

Detail / optional 350190

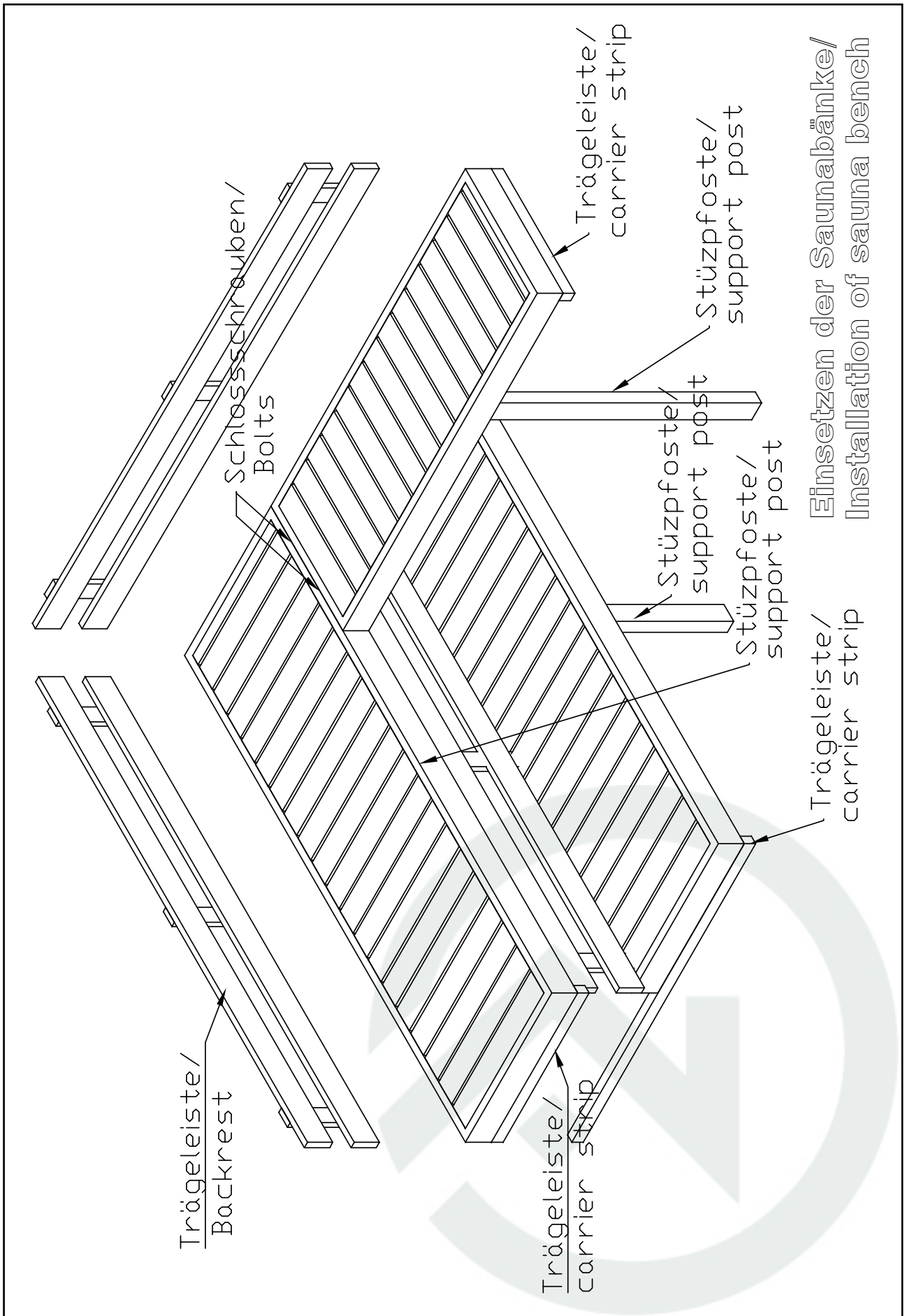

Detail / optional

350190

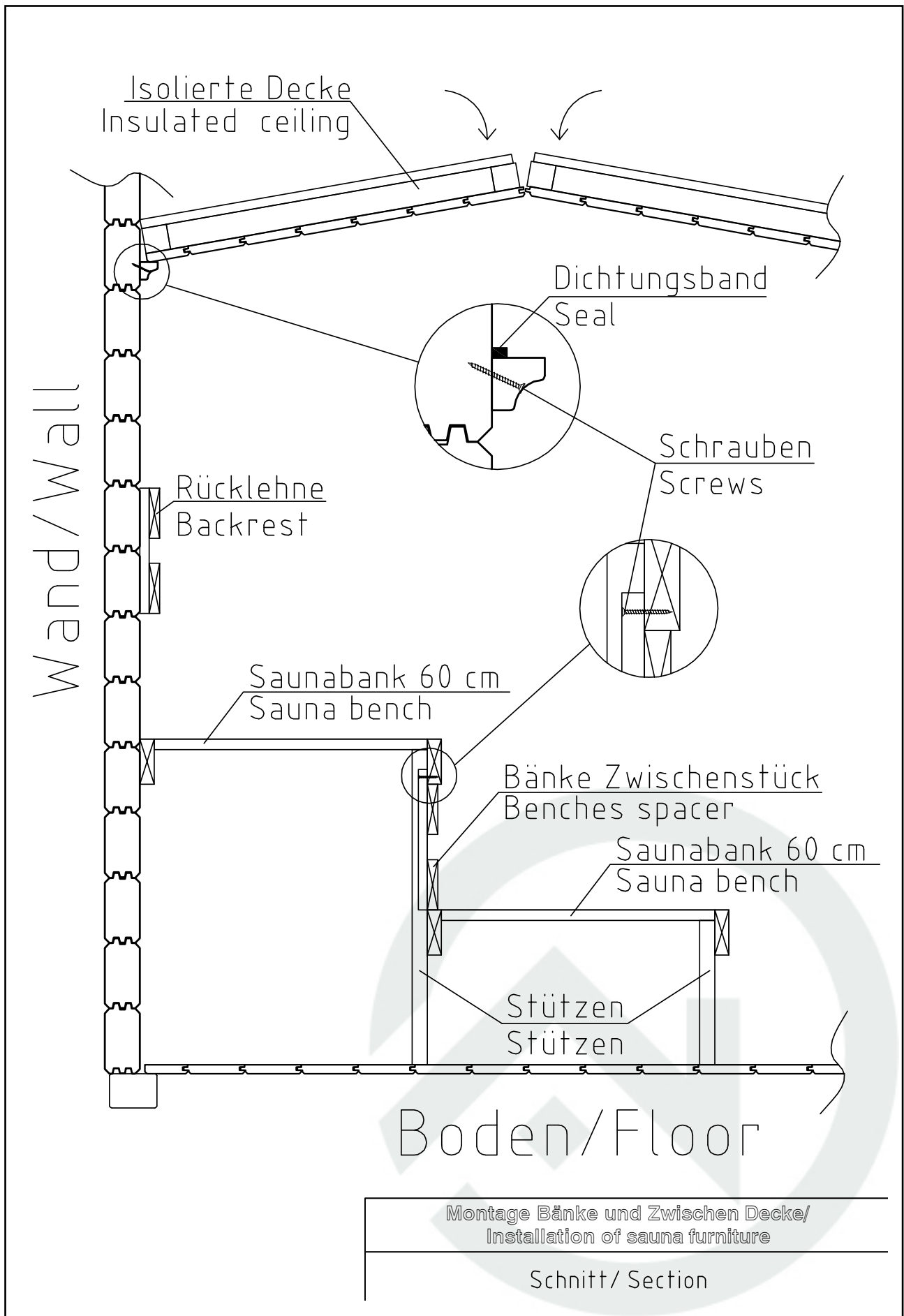

Detail / optional

350190

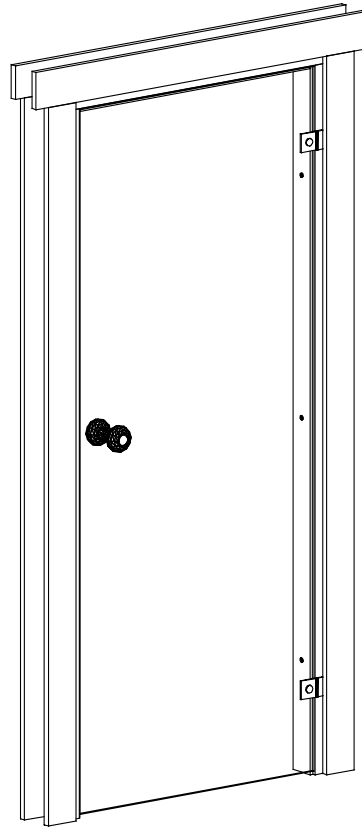

18x90 Blendleisten/
cover strips/piirdeliistud

Rahmenleisten
20x Wandstärke/
frame extensions
20x wall thickness/
laiendusliist
20x seinä paksus

18x90 Blendleisten/
cover strips/piirdeliistud

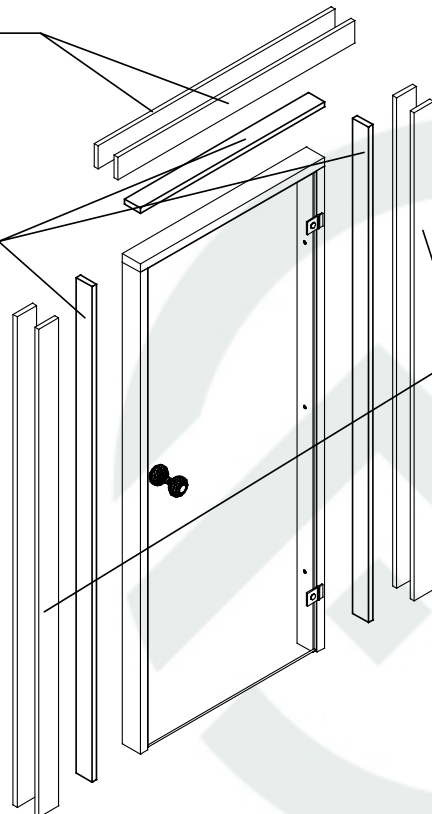

Detail / optional

350190

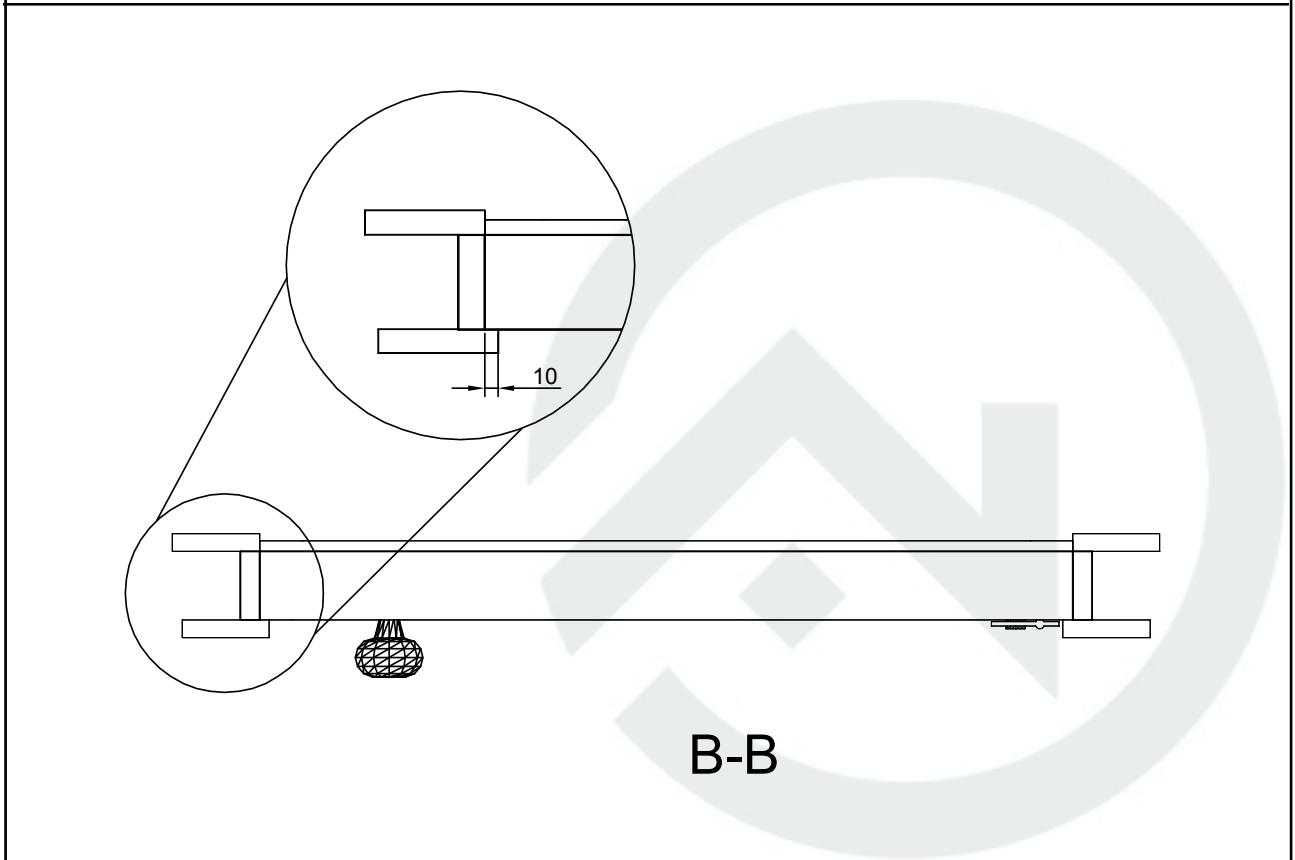
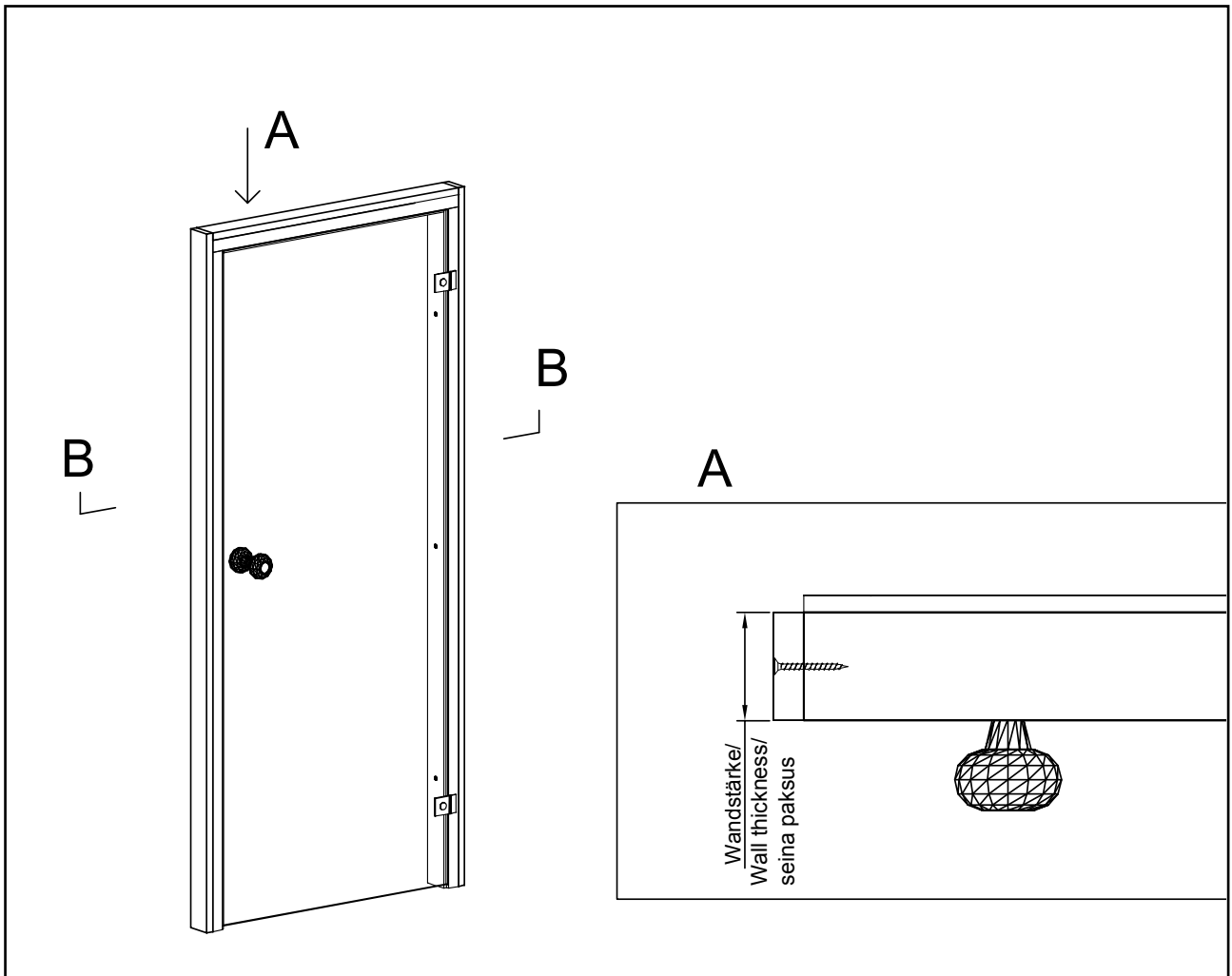

Detail / optional

350190

